

Important notice

Dear Customer,

On 7 February 2017 the former NXP Standard Product business became a new company with the tradename **Nexperia**. Nexperia is an industry leading supplier of Discrete, Logic and PowerMOS semiconductors with its focus on the automotive, industrial, computing, consumer and wearable application markets

In data sheets and application notes which still contain NXP or Philips Semiconductors references, use the references to Nexperia, as shown below.

Instead of <http://www.nxp.com>, <http://www.philips.com/> or <http://www.semiconductors.philips.com/>, use <http://www.nexperia.com>

Instead of sales.addresses@www.nxp.com or sales.addresses@www.semiconductors.philips.com, use salesaddresses@nexperia.com (email)

Replace the copyright notice at the bottom of each page or elsewhere in the document, depending on the version, as shown below:

- © NXP N.V. (year). All rights reserved or © Koninklijke Philips Electronics N.V. (year). All rights reserved

Should be replaced with:

- © **Nexperia B.V. (year). All rights reserved.**

If you have any questions related to the data sheet, please contact our nearest sales office via e-mail or telephone (details via salesaddresses@nexperia.com). Thank you for your cooperation and understanding,

Kind regards,

Team Nexperia

APPLICATION NOTE

- TDA8768AH/TDA8768BH - 12-BIT HIGH-SPEED A/D CONVERTER DEMONSTRATION BOARD

AN/10142

Authors:

**Stéphane JOUIN
Raymond MAUGIS**

**System & Application Data Converter - Caen
FRANCE**

Keywords:

TDA8768AH
TDA8768BH
Demoboard
12-bit ADC
High speed
Application Note

Date: May 2002

REVISION HISTORY

REVISION	DATE	EDITOR	REFERENCE	REMARKS
1.0	June 1999	Raymond MAUGIS	AN/99031	- TDA8768A - DEMONSTRATION BOARD
2.0	March 2001	Stéphane JOUIN	AN/01007	- TDA8768A/C2 - DEMONSTRATION BOARD (update from C1 to C2 version)
2.1	July 2001	Stéphane JOUIN	AN/01029	- TDA8768A/C2 - DEMONSTRATION BOARD (update pages #6, #9 and #14)
3.0	May 2002	Stéphane JOUIN	AN/10142-01	- TDA8768AH/TDA8768BH - DEMONSTRATION BOARD

Users are responsible for ensuring that they use the correct version of this document.

CONTENTS



1. MAIN FEATURES OF THE TDA8768AH AND THE TDA8768BH:	6
2. PRINCIPLE AND DESCRIPTION OF THE BOARD:	7
3. OVERVIEW OF THE BOARD:	9
4. PCB DESIGN:	11
4.1 MICROSTRIP LINES:	12
4.2 POWER SUPPLY WIRE:	12
4.3 ANALOG AND DIGITAL RETURN GROUND POINT:	12
5. SPECIAL FEATURES OF THE APPLICATION BOARD:	13
5.1 ADC ANALOG INPUTS VI AND VIN:	14
5.2 DATA OUTPUT D0 TO D11:	15
5.3 IR-RANGE OUTPUT IR:	18
5.4 ADC ANALOG, DIGITAL AND OUTPUT STAGES POWER SUPPLIES:	18
5.5 DC LEVEL AND FULL-SCALE CONTROL:	19
6. ENVIRONMENT CIRCUITS:	20
6.1 GENERAL POWER SUPPLY:	20
6.2 CLOCK GENERATION:	22
7. OPERATING MODE:	29
7.1 EXTERNAL SINGLE CLOCK OPERATION:	29
8. PERFORMANCES:	30
8.1 DEFINITION OF THE MEASURING PARAMETERS:	31
8.2 MEASUREMENT OF THE 40MSPS VERSION (TDA8768AH/4):	33
8.3 MEASUREMENT OF THE 55MSPS VERSION (TDA8768AH/5):	34
8.4 MEASUREMENT OF THE 70MSPS VERSION (TDA8768AH/7):	35
8.5 MEASUREMENT OF THE 80MSPS VERSION (TDA8768BH/8):	37
8.6 MEASUREMENT OF THE 80MSPS VERSION (TDA8768BH/8/S1):	38
8.7 MEASUREMENT OF THE 52MSPS VERSION (TDA8768BH/5):	39
9. DEMOBOARD FILES:	41
9.1 TDA8768AH/TDA8768BH VERSION:	41
9.2 COMPONENTS LIST:	41
10. ALGORITHMS USED:	48

SUMMARY

The **TDA8768A** and the **TDA8768B** are 12-bit high-speed Analog-to-Digital Converters designed for cellular phone infrastructures, professional telecommunications, professional imaging, advanced FM radio and other applications. They convert a analog input signal into 12 bits binary or into two's complement digital words at a maximum sampling rate of 70 Mega sample per second for the **TDA8768A** and at a maximum sampling rate of 80MSPS for the **TDA8768B**.

Three versions of **TDA8768A** device exist in QFP44 package: the **TDA8768AH/4**, the **TDA8768AH/5** and the **TDA8768AH/7** corresponding respectively to the clock frequency of 40, 55 and 70MSPS.

Three versions of **TDA8768B** device exist in QFP44 package: the **TDA8768BH/5**, the **TDA8768BH/8** and the **TDA8768BH/8/S1** corresponding respectively to the clock frequency of 52 and 80MSPS. The **TDA8768BH/5** version is mainly used with a bandwidth of 200kHz around an input frequency of 175.4MHz. The **TDA8768BH/8** version is mainly used on the Nyquist bandwidth. The **TDA8768BH/8/S1** version is mainly used with a bandwidth of 5MHz around an input frequency of 50MHz.

This Application Note describes the design and the realization of the **Demonstration Board** using the **TDA8768AH** () or the **TDA8768BH** () versions (PCB n° 834-3) with an application environment.

All rights are reserved. Reproduction in whole or in part is prohibited without the prior written consent of the copyright owner.

The information presented in this document does not form part of any quotation or contract, is believed to be accurate and reliable and may be changed without notice. No liability will be accepted by the publisher for any consequence of its use. Publication thereof does not convey nor imply any license under patent or other industrial or intellectual property rights.

1. MAIN FEATURES OF THE TDA8768AH AND THE TDA8768BH:

The **TDA8768AH** and the **TDA8768BH** are 12-bit Analog-to-Digital Converters. They can convert a typical analog input signal into 12 bits binary digital words at a maximum sampling rate of 70Msps with a typical power dissipation of 550mW for the **TDA8768AH** and at a maximum sampling rate of 80Msps with a typical power dissipation of 570mW for the **TDA8768BH**.

The **TDA8768AH** and the **TDA8768BH** code the binary or the two's complement digital words with 3.3V CMOS digital outputs. The main specifications points of **TDA8768AH** are:

- Clock frequency: 40, 55 or 70Msps.
- Output voltage: 3.3V.
- Power dissipation (typical): 550mW.
- Accuracy: 12-bit.
- Supply: 5V with output stages at 3.3V.
- Compatibility: input: TTL and CMOS,
output: TTL and CMOS (3.3V).

The main specifications points of **TDA8768BH** are:

- Clock frequency: 52 or 80Msps.
- Output voltage: 3.3V.
- Power dissipation (typical): 570mW.
- Accuracy: 12-bit.
- Supply: 5V with output stages at 3.3V.
- Compatibility: input: TTL and CMOS,
output: TTL and CMOS (3.3V).

2. PRINCIPLE AND DESCRIPTION OF THE BOARD:

The principle of the **Demonstration Board** for the **TDA8768A** or **TDA8768BH**, which is described in this Application Note, is shown on **Figure 1**.

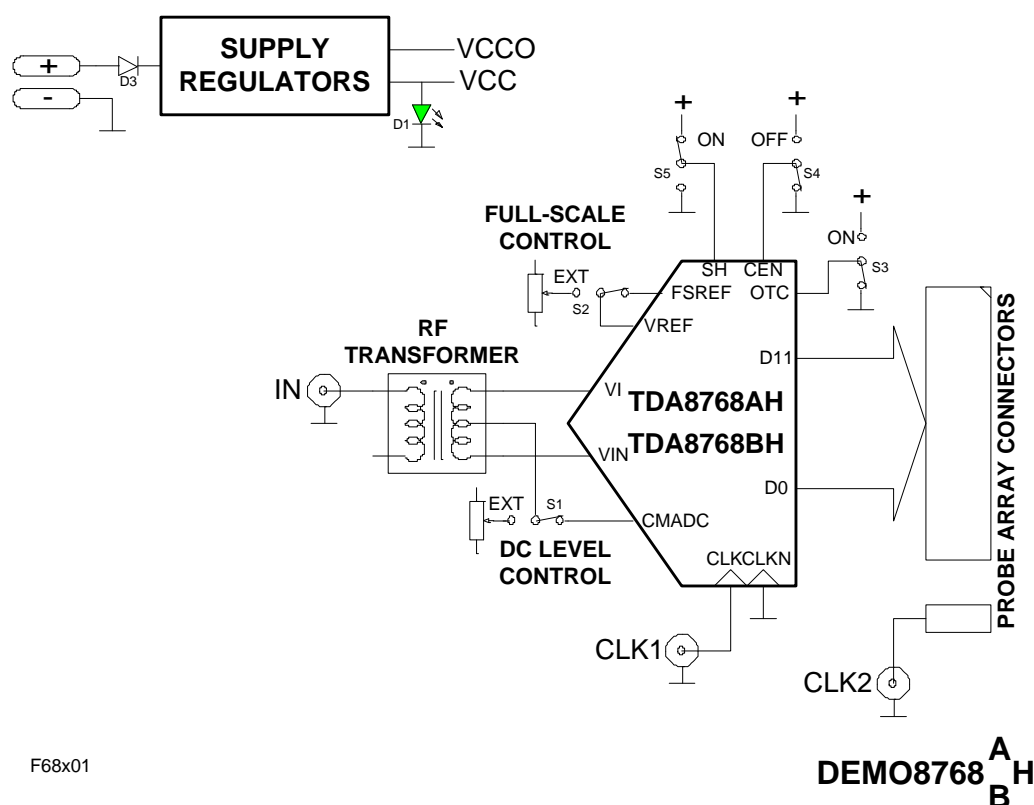

- Figure 1. Functional block diagram of Demoboard -

The different blocks of the **Demoboard** are:

- A power **supply regulators** used to supply all the circuitry on the board.
- A **RF transformer** transforming the single analog signal applied on the board into symmetrical differential analog signal on the ADC analog inputs .
- A **DC level control** fixing the ADC common mode voltage of the differential analog inputs from supply regulators.

- A **full-scale control** adjusting the ADC full-scale from supply regulators.
- A **probe array connectors** connecting probes of a logic analyser.
- A **TDA8768AH or TDA8768BH** Analog-to-Digital Converter converting an analog signal into 12 bits binary digital words.

The **Demoboard** works with a single +12V_{DC} external power supply. All circuitry is protected from reverse polarity. The right supply plugging is indicated by the green LED.

The sample clock signal on the **Demoboard** is available by plugging a square generator in the **CLK1** SMA connector. The output impedance of this generator must be 50Ω.

3. OVERVIEW OF THE BOARD:

The whole implantation of the **TDA8768AH/TDA8768BH Demoboard** version is shown on **Figure 2**.

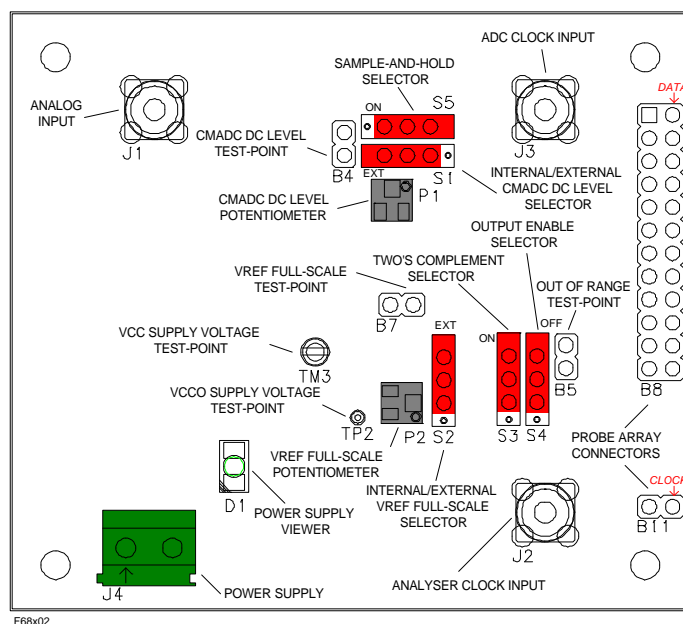

- Figure 2. Overview of Demoboard -

The different connectors, potentiometers, switches, lights and test-points available on the board are:

- **For the general power supply:**

1. A two-points PHOENIX connector **J4** for **12V_{DC}** and **GND**.
2. A test-point **TM3** to control the **VCC** supply voltage.
3. A test-point **TP2** to control the **VCCO** supply voltage used only by the ADC stages outputs.
4. A **PWR** green light **D1** to indicate the right supply plugging.

- **For the DC level control:**

1. A switch **S1** to choose the internal or the **EXT** external common mode of the ADC.
2. A potentiometer **P1** to adjust the **CMADC** common mode of the ADC when the switch **S1** is on **EXT**.
3. A test-point **B4** to control the **CMADC** common mode ADC value.

- **For the full-scale control:**

1. A switch **S2** to choose the internal or the **EXT** external reference voltage.
2. A potentiometer **P2** to adjust the **VREF** reference voltage when the switch **S2** is on **EXT**.
3. A test-point **B7** to control the **VREF** reference voltage value.

- **For the evaluation of the TDA8768AH or TDA8768BH:**

1. A SMA **J1** connector with 50Ω equivalent impedance for the analog input signal **IN**.
2. A SMA **J3** connector with 50Ω for the external clock input **CLK1**.
3. A switch **S3** to choose the ADC two's complement outputs by the input **OTC**.
4. A switch **S4** to enable the ADC outputs by the input **CEN**.
5. A switch **S5** to enable the sample-and-hold by the input **SH**.
6. A test-point **B5** indicating the out of range state of the analog input signal.

- **For the reconstruction of the analog input waveform:**

1. Twelve-probe array connectors **B8** corresponding to the ADC digital outputs **D0** to **D11** are available to connect the logic analyser which acquires the data.
2. A SMA **J2** connector with 50Ω, connected to probe array connectors **B11**, corresponding to the clock of the logic analyser.

4. PCB DESIGN:

The design is made on a multilayer **Printed Circuit Board**. The technological concept used to make this PCB is given on **Figure 3**.

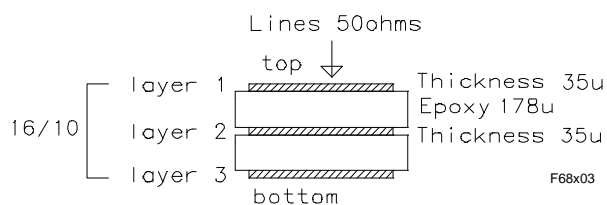

- Figure 3. PCB structure -

Three physical copper layers are used. The first layer is the signal layer which contains the microstrip lines. The second layer is made of the ground planes corresponding to the signal layer. The third layer is designed specially for the power supply wires.

The metallic hole technique is used to make all the necessary interconnections between the layers. The dielectric substrate is an Epoxy Glass resin with a relative permittivity (ϵ_r) of 4.7 and a copper thickness of $35\mu\text{m}$ ($\approx 1.4\text{mils}$). The substrate thickness is $\approx 178\mu\text{m}$ (7mils) between the copper layers.

4.1 MICROSTRIP LINES:

To calculate the width (**W**) of these 50Ω matched lines, the Kaup's relation was used:

$$W = \frac{5.98H}{0.8e^{\frac{Z_0\sqrt{e_r+1.41}}{87}}} - \frac{t}{0.8},$$

(Accurate to within 5% when $0.1 < \frac{W}{H} < 3.0$ and $1 < e_r < 15$).

hence:

$$W = 10.9\text{mils}/\approx 277\mu\text{m},$$



where:

$$\begin{aligned} Z_0 &= 50\Omega, \\ t &= 1.4\text{mils}/\approx 35\mu\text{m}, \\ H &= 7\text{mils}/\approx 178\mu\text{m}, \\ e_r &= 4.7. \end{aligned}$$

4.2 POWER SUPPLY WIRE:

To reduce the voltage fluctuation effects due to switching currents inside the integrated circuits, the power supply wires are designed with a low characteristic impedance of microstrip lines in order to obtain a small equivalent inductance.

4.3 ANALOG AND DIGITAL RETURN GROUND POINT:

To minimise the noise due to capacitive coupling between the analog input and the digital output parts of the ADC, two separate ground planes (analog  and digital ) are designed on all layers and are connected together through an inductor.

5. SPECIAL FEATURES OF THE APPLICATION BOARD:

To obtain optimal performances, the recommended application diagram is given on **Figure 4**.

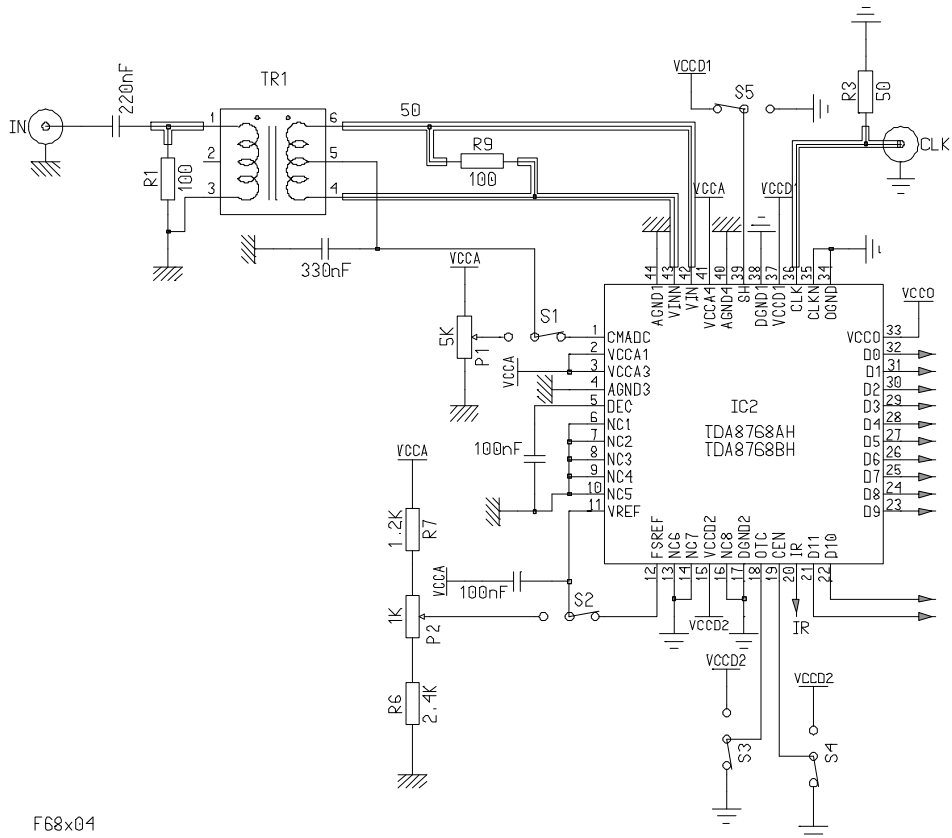

F68x04

- Figure 4. TDA8768AH/TDA8768BH application diagram -

5.1 ADC ANALOG INPUTS VI AND VIN:

The dynamic ADC analog signals VI and VIN are connected through a 1:1 RF wideband transformer and a 220nF AC coupling to the external generator by the **IN** SMA connector. This connector is adapted by a 50Ω microstrip line and is connected to a 100Ω resistor. This value is calculated to have 50Ω equivalent ending: A 100Ω resistor connected between the both ADC analog inputs ensures a 50Ω matching and creates an analog virtual ground. Thereby with transformer ratio 1:1 and with the two 100Ω resistors, the equivalent impedance ending is 50Ω. The combination of the C capacitor and the R/2 equivalent impedance on the primary transformer forms a high-pass filter whose the -3dB cut-off frequency is determined by the relation:

$$f_{-3dB} = \frac{1}{\pi RC}.$$



The peak-to-peak magnitude nominal value $V_{I_{p-p}}$ of the dynamic input signal is dependent on the VREF reference voltage applied on the corresponding pin of the device. With the typical values of VREF reference (VCC-1.75V), the $V_{I_{p-p}}$ of the dynamic input signal is 1.9V. The quantum of the **TDA8768AH** or **TDA8768BH** is defined by:

$$q = \frac{V_{I_{p-p}}}{2^{12} - 1},$$

hence,

$$q \approx 463\mu V.$$

The sample-and-hold mode is chosen with the switch **S5**. The sample-and-hold selection is given on **Table 1**.

SH	Sample-and-hold	Frequency	Switch
1	active	$7\text{MHz} \leq f_{\text{clk}} \leq 70\text{MHz}$	
0	Inactive; tracking mode	$f_i \leq 1\text{MHz}$	

- Table 1: Sample-and-hold selection -

5.2 DATA OUTPUT D0 TO D11:

All data outputs of the **TDA8768AH** or **TDA8768BH** are 3.3V CMOS compatible and they are directly addressed to a probe array connectors. The guaranteed levels with the maximum load capacitance ($C_L = 10\text{pF}$) are:

$$V_{OLmax} = 0.5V,$$

$$V_{OHmin} = V_{CCO} - 0.5V,$$

The typical output transient time (measured on one sample) is :

$$t_{T(10\%-90\%)} = 6\text{ns}.$$

The output slew-rate can be estimated from the relation:

$$\frac{dV}{dt} = \frac{80\%(V_{OH} - V_{OL})}{t_{T(10\%-90\%)}} ,$$

hence:

$$\frac{dV}{dt} \approx 383\text{mV} / \text{ns} .$$

From the slew-rate relation, the bit switching current is calculated from the relation:

$$I_o = C_L \cdot \frac{dV}{dt} ,$$

hence:

$$I_o = 3.83\text{mA} / \text{bit} ,$$

where:

$$C_L = 10\text{pF}.$$

For the 12-bit ADC, the full-scale transition switching current is given by:

$$I_{FS} = n \cdot I_o,$$

hence:

$$I_{FS} \approx 46\text{mA},$$

where:

n: number of bits.

The output buffers of the **TDA8768AH** or **TDA8768BH** are designed to support these values. In the case where the load capacitance is higher than 10pF per bit, it is necessary to put a limiting serial resistor to adapt the slew-rate and to protect the ADC output buffers.

The switch **S3** corresponding to the two's complement input **OTC** allows the choice of either the binary or the *two's complement* digital words which correspondence is given on **Table 2** (in fact, *the two's complement* digital words corresponds to the binary digital words with the inverted MSB **D11**). The *two's complement* is enabled when the switch **S3** is on **ON**.

Step	IR	Binary outputs bits D11 to D0	Two's complement output bits D11 to D0
U/F	0	000000000000	100000000000
0	1	000000000000	100000000000
1	1	000000000001	100000000001
.	.	.	.
2047	1	011111111111	111111111111
.	.	.	.
4094	1	111111111110	011111111110
4095	1	111111111111	011111111111
O/F	0	111111111111	011111111111

- Table 2: Binary/Two's complement output coding -

The switch **S4** corresponding to the output enable input **CEN** allows either to enable or to put them in high impedance state when is on **OFF**.

On the **Table 3** is given the relationship between the different choices.

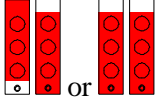
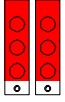
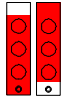
OTC	CEN	D11 to D0	IR	Switches
X	1	high impedance		
0	0	binary	active	
1	0	<i>two's complement</i>	active	

- *Table 3: Selection mode* -

5.3 IR-RANGE OUTPUT IR:

The in-range output **IR** pin is directly connected to the test-point **B5**. When the underflow or overflow of the **VI** analog input signal is detected, the level on the test-point **B5** is low. The functional diagram is shown on **Figure 5**.

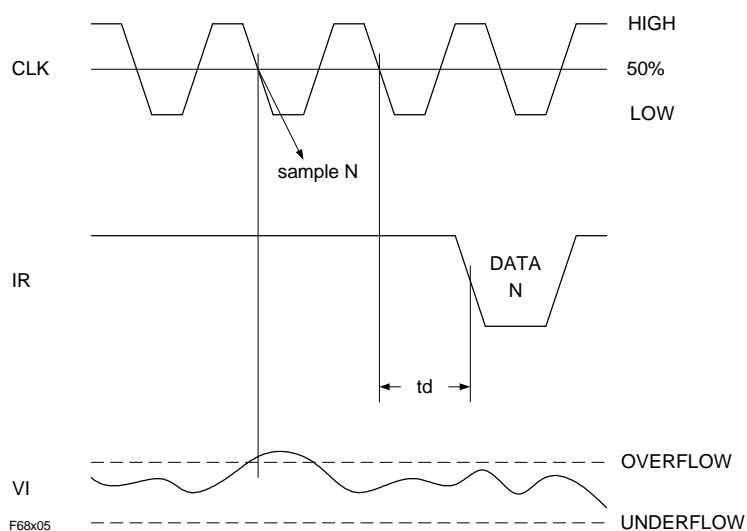

- Figure 5. IR waveform -

5.4 ADC ANALOG, DIGITAL AND OUTPUT STAGES POWER SUPPLIES:

Two power supplies of 5V and 3.3V are necessary to supply the **TDA8768AH** or **TDA8768BH** respectively for the analog and digital pins and for the output stages.

To ensure a good bypassing at low and high frequencies, the use of several different parallel capacitors is required and SMD bypass π type filters are implanted on the board near the ADC on each power pin.

5.5 DC LEVEL AND FULL-SCALE CONTROL:

The DC level control fixed on the middle point of the transformer secondary is supplied either by the **TDA8768AH/TDA8768BH** (from **CMADC** pin) or by the potentiometer **P2** when the switch **S1** is on **EXT** (). The test-point **B4** allows to control the voltage. The value of the common mode voltage is given by:

$$V_{CMADC} = V_{CC} - 1.6V .$$

A 330nF AC coupling is added on the middle point of the transformer secondary to get a good "dynamic" ground.

The full-scale control is supplied either by the **TDA8768AH/TDA8768BH** (from **FS_{ref}** pin) or by the potentiometer **P2** and the resistors **R6** and **R7** when the switch **S2** is on **EXT** (). The test-point **B7** allows to control the voltage value of **VREF**. The value of the reference voltage is given by:

$$V_{REF} = V_{CC} - 1.75V .$$

6. ENVIRONMENT CIRCUITS:

6.1 GENERAL POWER SUPPLY:

The electrical diagram is shown on **Figure 6**. An IC voltage regulator **IC1** is used directly mounted on the board and it is supplied from an external DC power unit of 12V_{DC}/150mA for **TDA8768AH** and for **TDA8768BH**. Nevertheless, the external voltage can range from 10V_{DC} to 15V_{DC}. From the IC voltage regulator, a second voltage is created to supply only the output buffers of the device.

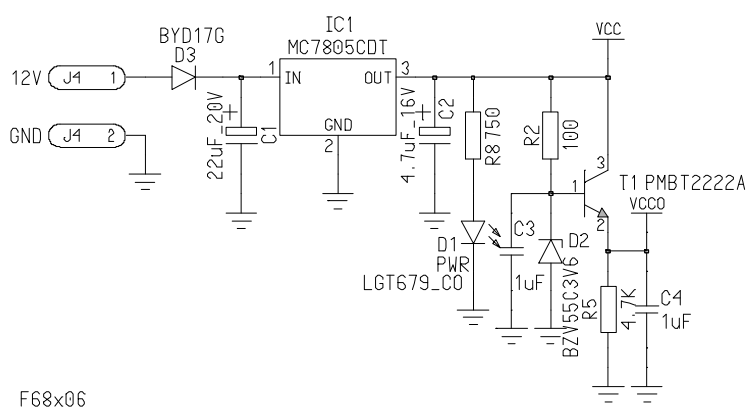

- Figure 6. Electric diagram of the power supply -

The regulation and the stabilisation of all circuitry come from the voltage value obtained after the protection diode **D3**. A stabilised voltage **VCC** of 5V is made from the MC7805CDT voltage regulator **IC1**. From the **VCC**, a second voltage **VCCO** of 3.3V, suppling the ADC output buffers, is made from the PMBT222A NPN transistor **T1** and the BZV55C3V6 zener diode **D2**. The **VCCO** voltage value is given by the relation

$$VCCO = V_z - V_{BE},$$

The maximum output current is fixed to 100mA in order to support the full-scale switching current (see chapter 5.2).

The transistor base current is given by the relation:

$$I_B = \frac{I_{FS}}{\beta},$$

where:

$I_{FS} = 100\text{mA}$ (full-scale switching current),

$\beta = 100$.

To ensure a sufficient stability, the current in zener diode is fixed at ten times the transistor base current, hence:

$$I_z = \frac{10 \cdot I_{FS}}{\beta},$$

so:

$$R2 = \frac{VCC - V_Z}{I_z + I_B},$$

hence:

$$\mathbf{R2 = 100\Omega.}$$

The distribution of the voltage is:

VCC used for:

ADC digital and analog supply voltages.

VCCO used for:

ADC output stages supply voltage.

The BYD17G Silicon diode **D3** ensures the protection of all the circuitry from reverse polarities. The right supply plugging is indicated by a green LED **D1**.

6.2 CLOCK GENERATION:

On the Demoboard, the **CLK1** connector **J3** allows to drive the ADC clock input CLK with TTL/CMOS level. In this case, the complementary clock input CLKN is directly connected to the digital ground.

Nevertheless, the **TDA8768AH** can work with several logic families and can work with an AC signal given on **Table 4**, but the **TDA8768BH** works only with the TTL/CMOS logic family.

Logic family	CLK	CLKN
PECL	PECL	3.65V _{DC}
	3.65V _{DC}	PECL
	PECL	PECL
TTL/CMOS	TTL/CMOS	GNDD
	GNDD	TTL/CMOS
AC	0.5V _{p-p}	0.5V _{p-p}

- Table 4: Logic families and AC signal -

With:

PECL:

$$V_{IL} = 3.52V,$$

$$V_{IH} = 3.83V.$$

CMOS:

$$V_{IL} = 0.5V,$$

$$V_{IH} = V_{CC} - 0.5V.$$

TTL:

$$V_{IL} = 0.8V,$$

$$V_{IH} = 2.0V.$$

AC:

$$V = 1V_{p-p}.$$

For these logic families, different clock interface circuits can be adopted to drive the clock of the **TDA8768AH**.

About the PECL driving, two examples using a PECL single-ended/differential interface are given on **Figures 7 and 8**.

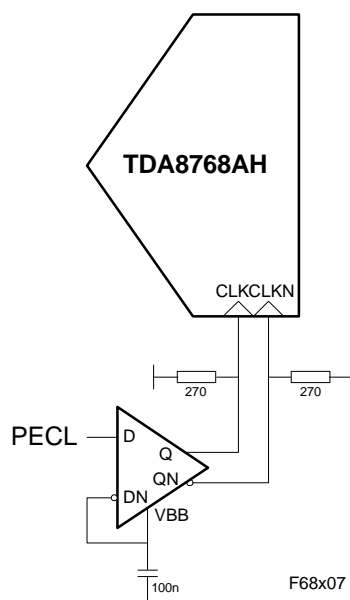

- Figure 7: First Example of PECL single-ended/differential interface -

A low skew PECL differential receiver can be used to translate directly the PECL single-ended into PECL differential signal connected to the **TDA8768AH** clock inputs. To preserve a duty cycle low skew on the differential clock signal, the transmission lines must have the same length which must be shorter than 1inch/2.54cm.

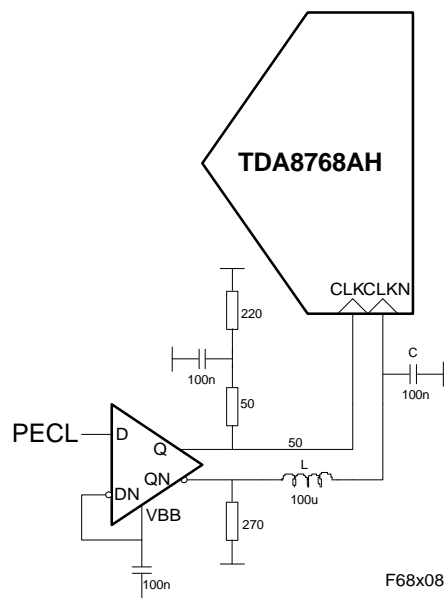

- Figure 8: Second Example of PECL single-ended/differential interface -

The PECL differential receiver must be located close to the **TDA8768AH** clock inputs. The offset voltage is restored on the CLKN clock input through the inductance L and the capacitor C from the QN PECL differential receiver output. The transmission line between the Q PECL differential receiver output and the CLK input of the device must be shorter than 1inch/2.54cm.

About the TTL(CMOS) driving, two examples using a TTL(CMOS)/TTL(CMOS) or a TTL/PECL interface are given on **Figure 9 and 10**.

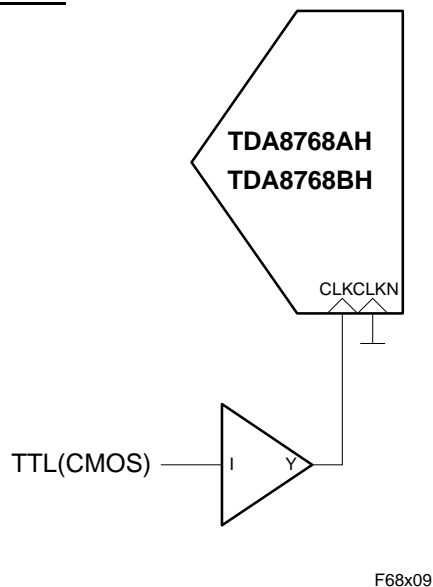

- Figure 9: Example of TTL(CMOS)/TTL(CMOS) interface -

The simple interface uses a TTL(CMOS) buffer/driver connected on the CLK clock input. In this case, the CLKN clock input is connected to the digital ground.

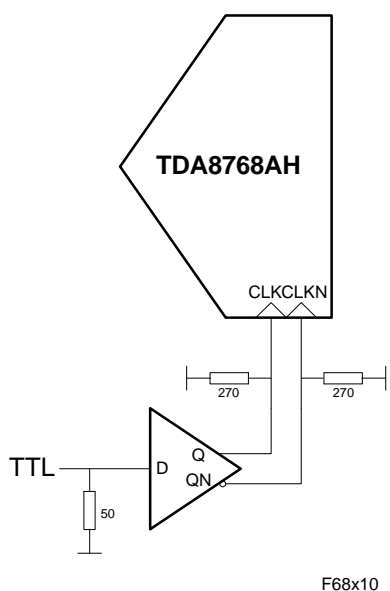

- Figure 10: Example of TTL/PECL interface -

A TTL to differential PECL translator can be used to make the adaptation between the TTL clock and the **TDA8768AH** clock inputs.

About the AC driving, two examples using a AC single-ended/differential or a RLC interface are given on **Figure 11 and 12**.

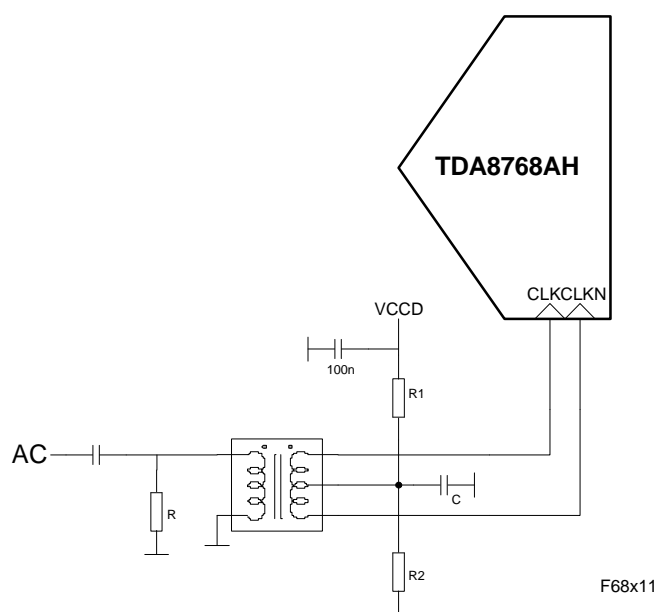

- Figure 11: Example of AC single-ended/differential interface -

With the RF transformer of 1:1 ratio, the primary load resistor must be chosen to match the source impedance. In this case, the **TDA8768AH** input impedance can be eliminated for the calculation. The supplied peak to peak amplitude delivered by the source signal must be higher than $1V_{p-p}$. The DC level voltage on the middle point of the transformer secondary is fixed by the resistor bridge R1 and R2. To ensure a stability of the DC level, the current in the resistor bridge must be higher than the specified high level input clock current I_{IH} of the device ($10 \times I_{IH}$ for example). The dynamic ground is ensured on the middle point by a wide-band decoupling C ($4.7\mu F$ in parallel with a $100nF$ capacitor for example).

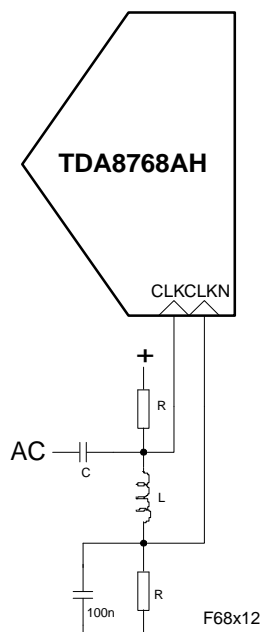

- Figure 12: Example of RLC interface -

The dynamic equivalent clock input circuit is given on the **Figure 13**.

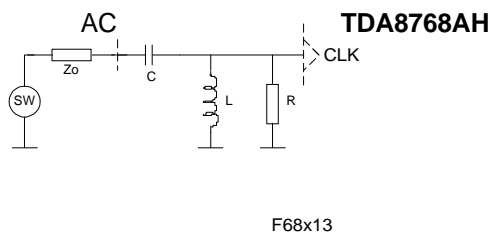

- Figure 13: Equivalent clock input -

At the clock frequency used, the following condition must be respected:

$$\frac{1}{C\omega_o} \ll |Z_{IN}|,$$

where:

F_o = clock frequency,

$$|Z_{IN}| = \frac{RL\omega_o}{\sqrt{R^2 + L\omega_o^2}}.$$

Therefore, if the resistor value R is sufficiently high, the inductance value L can be chosen in order to obtain the matching impedance on the output generation clock circuit.

The jitter value of the clock signal must be low otherwise some sampling errors can appear. The jitter value can be calculated from the slope of the sinewave input signal. The sinewave input signal is given by:

$$v(t) = \frac{v_{i_{FS}}}{2} \cdot \sin(2 \cdot \boldsymbol{p} \cdot f_i \cdot t),$$

where:

$$\begin{array}{ll} v_{i_{FS}} = 2^n \cdot q & : \text{ADC full scale,} \\ n & : \text{ADC bit number,} \\ f_i & : \text{input signal frequency.} \end{array}$$

So, the slope of the sinewave is:

$$\Delta v(t) = \Delta t \cdot \frac{f v(t)}{f t} = \Delta t \cdot \frac{v_{i_{FS}}}{2} \cdot 2 \cdot \boldsymbol{p} \cdot f_i \cdot \cos(2 \cdot \boldsymbol{p} \cdot f_i \cdot t).$$

The slope is maximum at $t_0=0$ (middle of the input full scale):

$$\Delta v(t_0) = \Delta t_0 \cdot v_{i_{FS}} \cdot \boldsymbol{p} \cdot f_i,$$

hence:

$$\Delta t_0 = \frac{\Delta v(t_0)}{2^n \cdot q \cdot \boldsymbol{p} \cdot f_i}.$$

For example, to have an jitter below the quantum ($\Delta v(t_0) = q$), it must be inferior at:

$$\Delta t_0 < 2.22\text{ps},$$

with:

$$\begin{array}{l} n = 12, \\ f_i = 35\text{MHz.} \end{array}$$

7. OPERATING MODE:

An external power unit of 12V_{DC}/150mA for **TDA8768AH** and for **TDA8768BH** is required to supply the **Demoboard**. However, the board is able to work between 10V_{DC} and 15V_{DC}.

All DC voltages of **P1** (CMADC) and **P2** (VREF) are locked in the **System & Application Data Converter** in Caen before delivery to be in accordance with the product specifications.

So:

$$\mathbf{CMADC = VCC - 1.6V,}$$

$$\mathbf{VREF = VCC - 1.75V,}$$

But the **VREF** and **CMADC** values may be modified by the user to obtain a different full-scale and DC level of input analog signals.

7.1 EXTERNAL SINGLE CLOCK OPERATION:

When an external 50Ω square clock generator is connected to **J3** connector, The required clock levels are:

$$\mathbf{V_{CLKH} \min = 2.0V,}$$

$$\mathbf{V_{CLKL} \max = 0.8V.}$$

8. PERFORMANCES:

An evaluation of the **TDA8768AH** and **TDA8768BH** ADC performances was made with the **Demoboard** environment on CAEN's dynamic bench which block diagram is given on **Figure 14**.

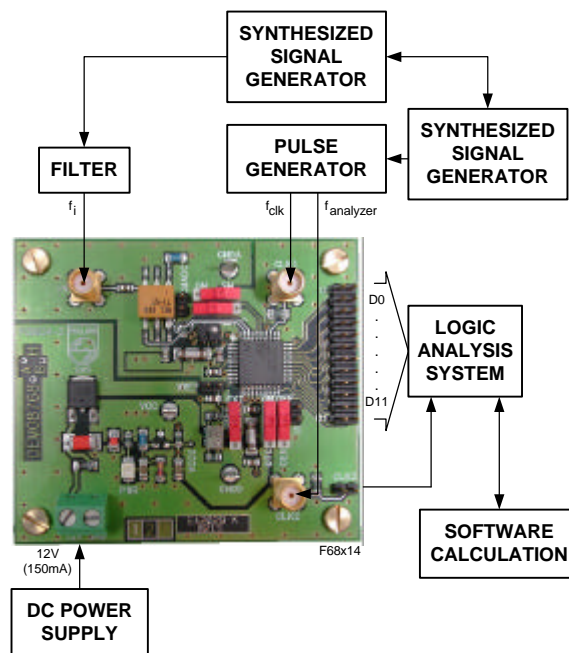

- Figure 14. CAEN's dynamic bench block diagram -

8.1 DEFINITION OF THE MEASURING PARAMETERS:

To evaluate the ADC performances on the Demoboard, the CAEN dynamic bench uses the **F**ast **F**ourier **T**ransform for dynamic parameters from the sample signal.

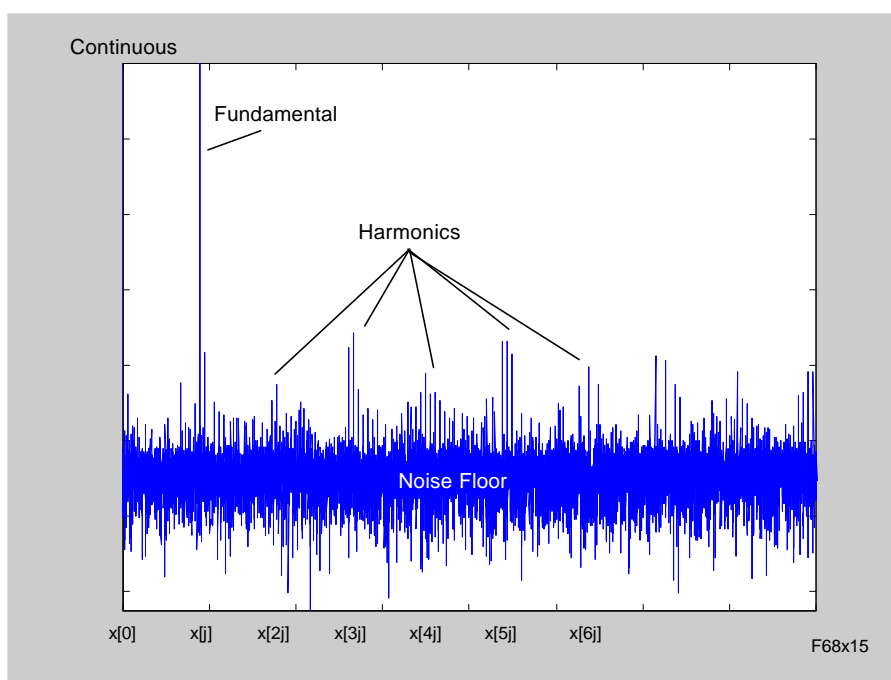

- Figure 15. FFT -

According to the FFT shown on **Figure 15**, the main dynamic parameters are:

- The **T**otal **H**armonic **D**istortion is the ratio between the RMS signal amplitude and the RMS sum of the first five harmonics. From the power spectrum of FFT, the **THD** is calculated from the relation:

$$\text{THD}_{\text{dBc}} = 20 \times \log_{10} \frac{x[j]}{\sqrt{\sum_{i=2}^6 x^2[i \times j]}}$$

Where:

- $x[j]$: fundamental component corresponding with the j spectrum component,
- $x[i \times j]$: component of harmonic i .

- The **Spurious Free Dynamic Range** is the ratio between the RMS signal amplitude and the RMS value of the highest spectrum component (harmonic or noise). From the FFT, the **SFDR** is calculated from the relation:

$$\text{SFDR}_{\text{dB}} = 20 \times \log_{10} \frac{x[j]}{\text{MAX}(x[i])}.$$

Where:

$x[i]$: spectrum component i with $i \in [2: \frac{N}{2}]$ (N : number of samples) and $i \neq x[j]$.

- The **Signal to Noise And Distortion** ratio is the ratio between the RMS signal amplitude and the RMS sum of all the other spectral components. From the FFT, the **SINAD** is calculated from the relation:

$$\text{SINAD}_{\text{dB}} = 20 \times \log_{10} \frac{x[j]}{\sqrt{\sum_{i=2, i \neq j}^{\frac{N}{2}} x[i]}}.$$

- The **Signal to Noise Ratio** is the ratio between the RMS signal amplitude and the RMS sum of all the other spectral components without harmonic used in the **THD** relation. From the FFT, the **SNR** is calculated from the relation:

$$\text{SNR}_{\text{dB}} = 20 \times \log_{10} \frac{x[j]}{\sqrt{\sum_{i=2, i \neq j \times [1:6]}^{\frac{N}{2}} x[i]}}.$$

- The **Effective number of bit** is calculated by the relation (valid to NYQUIST condition):

$$E_{\text{BIT}} = \frac{\text{SINAD} - 10 \times \log_{10} \frac{3}{2}}{20 \times \log 2}.$$

8.2 MEASUREMENT OF THE 40MSPS VERSION (TDA8768AH/4):

This version of the **Demoboard** is evaluated with the following measurement conditions:

Input frequency:	4.43MHz.
Waveform:	Sinewave.
Magnitude:	Full Scale.
Antialiasing Filter:	Yes
Clock frequency:	40MSPs.
Output format:	Binary.

The typical results and the corresponding diagrams obtained with these conditions are given on **Figure 16**

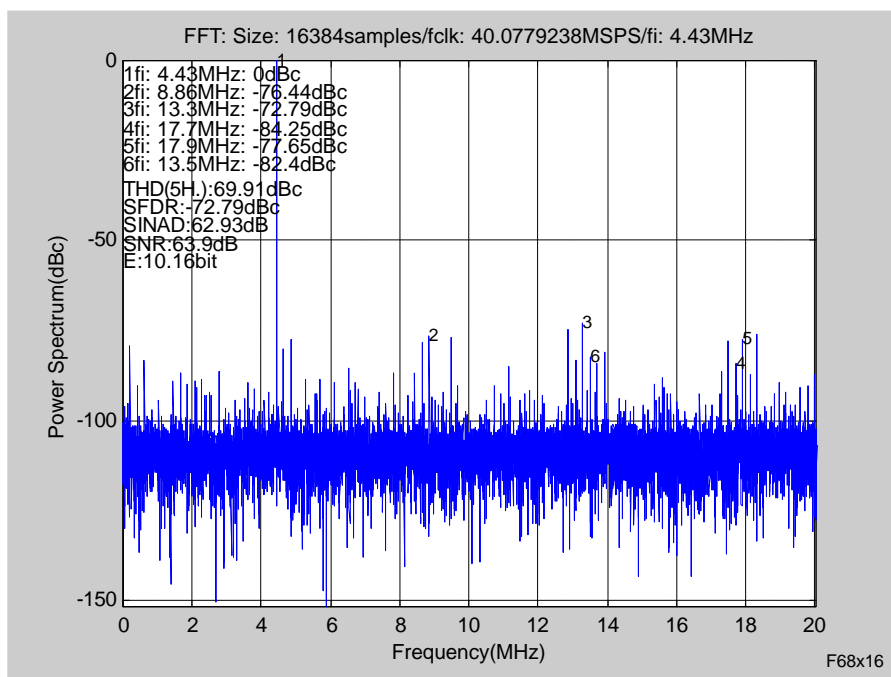

- Figure 16. FFT results at 4.43MHz@40MSPs -

8.3 MEASUREMENT OF THE 55MSPS VERSION (TDA8768AH/5):

This version of the **Demoboard** is evaluated with the following measurement conditions:

Input frequency:	4.43MHz.
Waveform:	Sinewave.
Magnitude:	Full Scale.
Antialiasing Filter:	Yes
Clock frequency:	55MSPs.
Output format:	Binary.

The typical results and the corresponding diagrams obtained with these conditions are given on **Figure 17**.

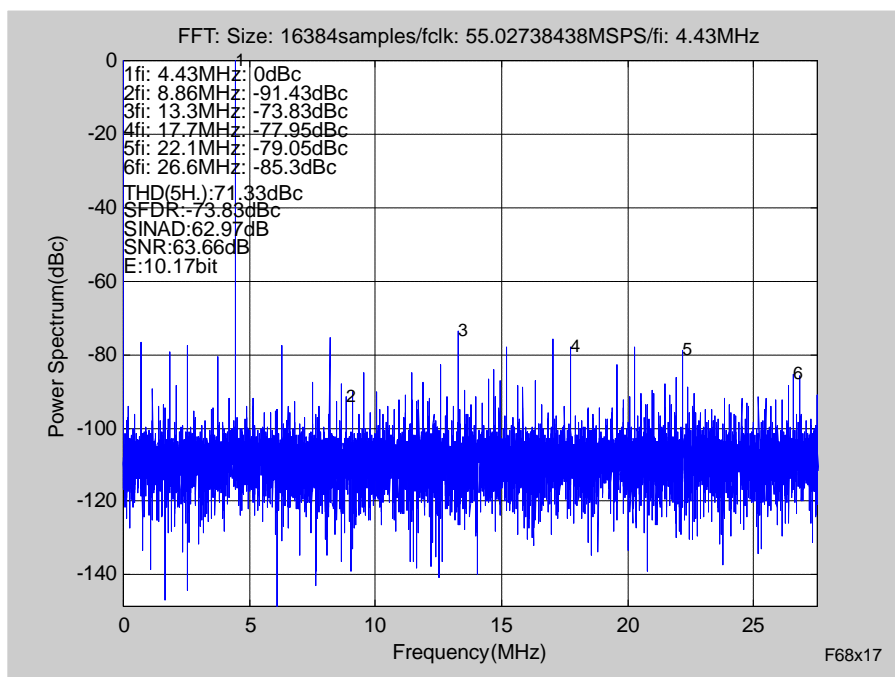

- Figure 17. FFT results at 4.43MHz@55MSPs -

8.4 MEASUREMENT OF THE 70MSPS VERSION (TDA8768AH/7):

This version of the **Demoboard** is evaluated with the following measurement conditions:

Input frequency:	4.43MHz/15MHz.
Waveform:	Sinewave.
Magnitude:	Full Scale.
Antialiasing Filter:	Yes
Clock frequency:	70MSPs.
Output format:	Binary.

The typical results and the corresponding diagrams obtained with these conditions are given on **Figure 18** for the 4.43MHz input frequency and on **Figures 19 to 20** for the 15MHz input frequency.

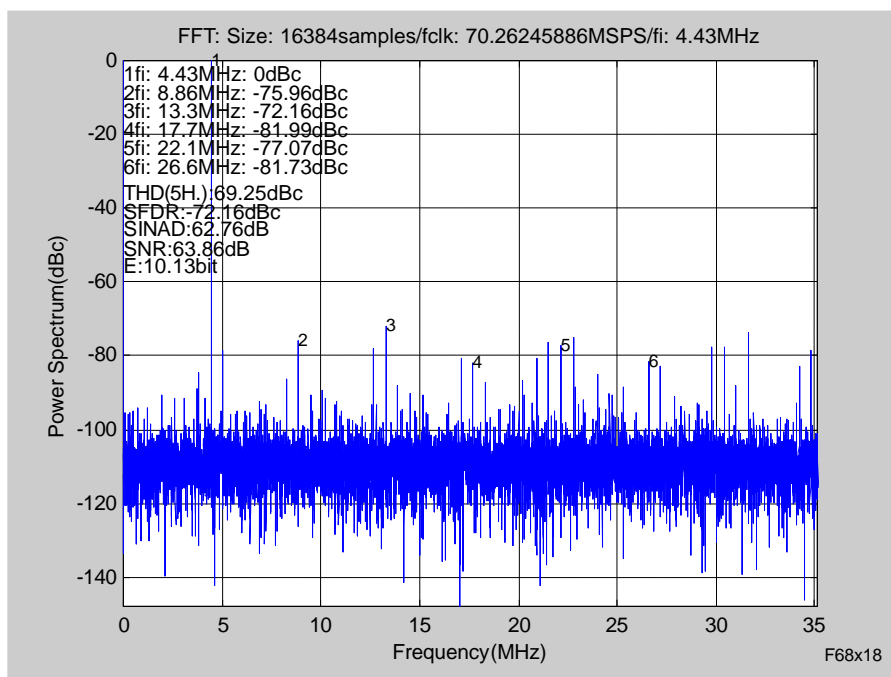

- Figure 18. FFT results at 4.43MHz@70MSPs -

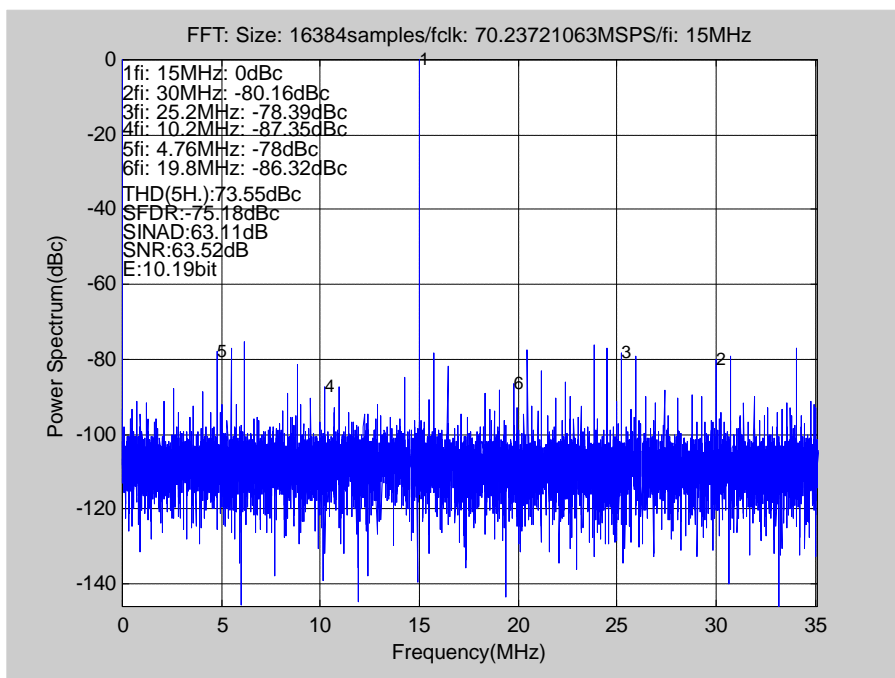

- Figure 19. FFT results at 15MHz@70MSPs -

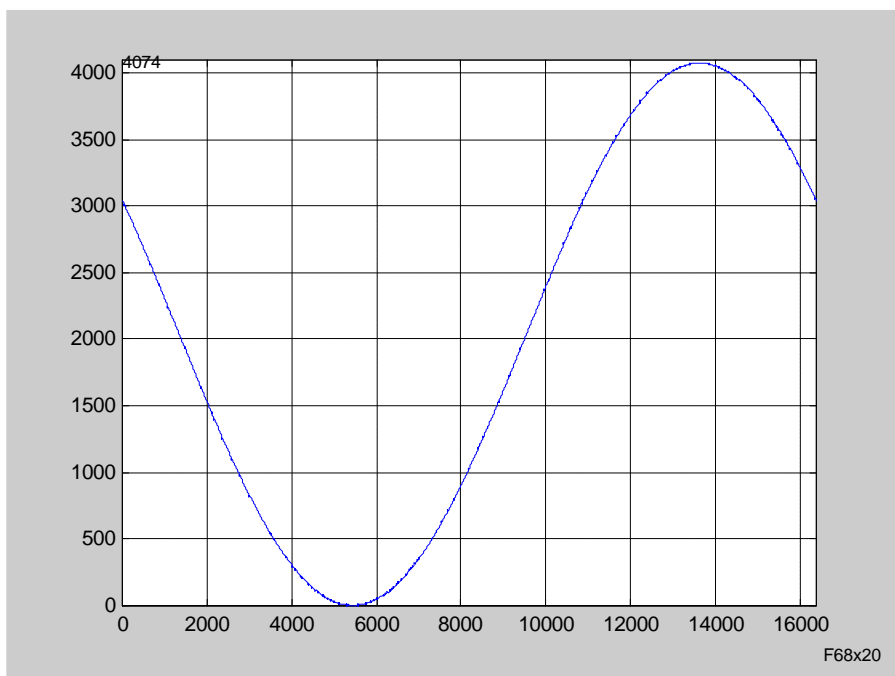

- Figure 20. Reconstructed signal at 15MHz@70MSPs -

8.5 MEASUREMENT OF THE 80MSPS VERSION (TDA8768BH/8):

This version of the **Demoboard** is evaluated with the following measurement conditions:

Input frequency:	4.43MHz.
Waveform:	Sinewave.
Magnitude:	Full Scale.
Antialiasing Filter:	Yes
Clock frequency:	80MSPs.
Output format:	Binary.

The typical results and the corresponding diagrams obtained with these conditions are given on **Figure 21**.

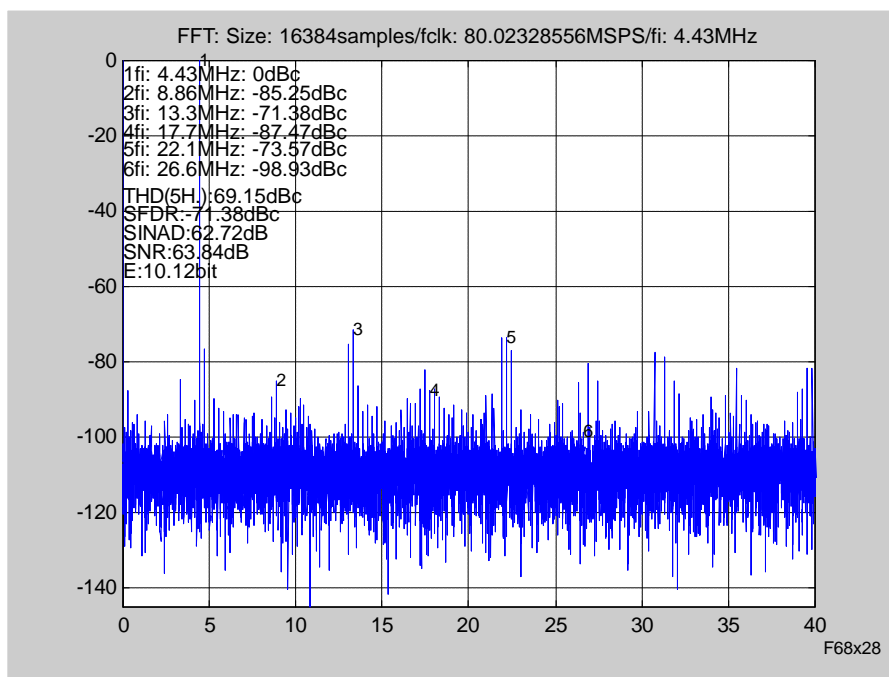

- Figure 21. FFT results at 4.43MHz@80MSPs -

8.6 MEASUREMENT OF THE 80MSPS VERSION (TDA8768BH/8/S1):

This version of the **Demoboard** is evaluated with the following measurement conditions:

Input frequency:	50MHz.
Waveform:	Sinewave.
Magnitude:	Full Scale.
Antialiasing Filter:	Yes
Clock frequency:	80Msps.
Output format:	Binary.

The typical results and the corresponding diagrams obtained with these conditions are given on **Figure 22**.

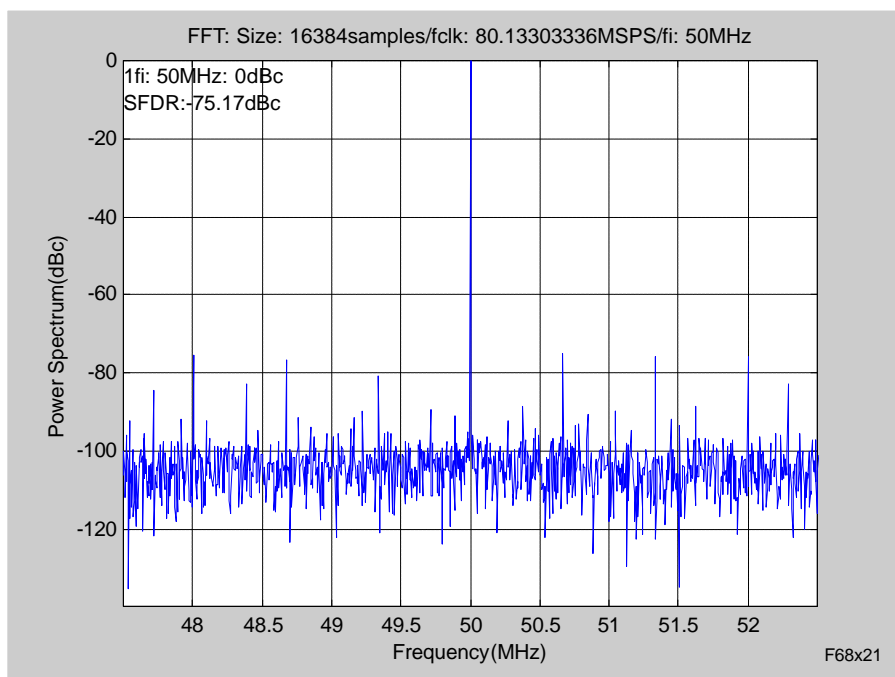

- Figure 22. FFT results at 50MHz@80Msps on 5MHz of bandwidth -

8.7 MEASUREMENT OF THE 52MSPS VERSION (TDA8768BH/5):

This version of the **Demoboard** is evaluated with the following measurement conditions:

Input frequency:	175.4MHz.
Waveform:	Sinewave.
Magnitude:	Full Scale.
Antialiasing Filter:	Yes
Clock frequency:	52MSPs.
Output format:	Binary.

The typical results and the corresponding diagrams obtained with these conditions are given on **Figures 23 to 24**.

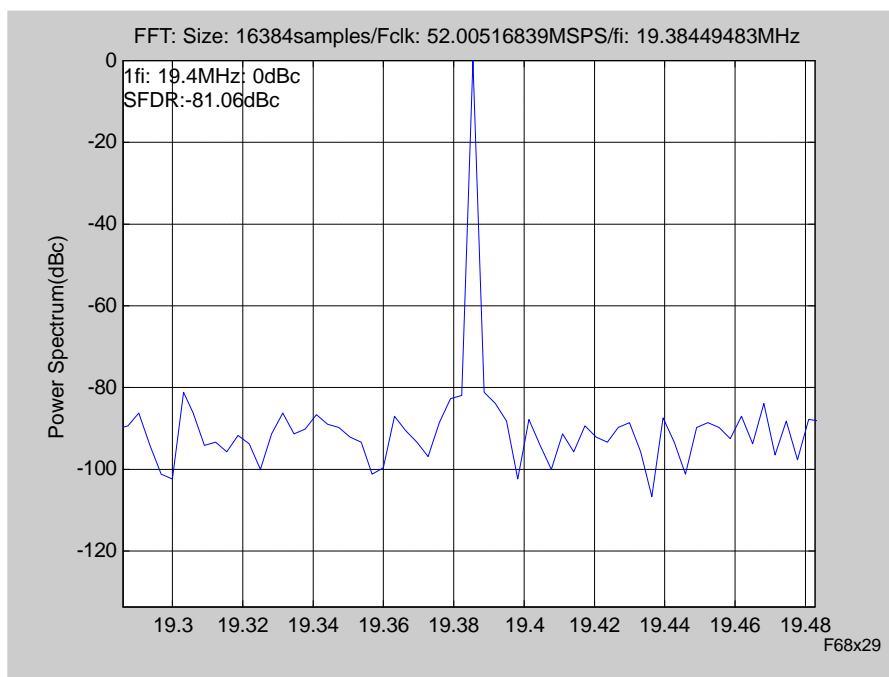

- Figure 23. FFT results at 175.4MHz@52MSPs on 200kHz of bandwidth -

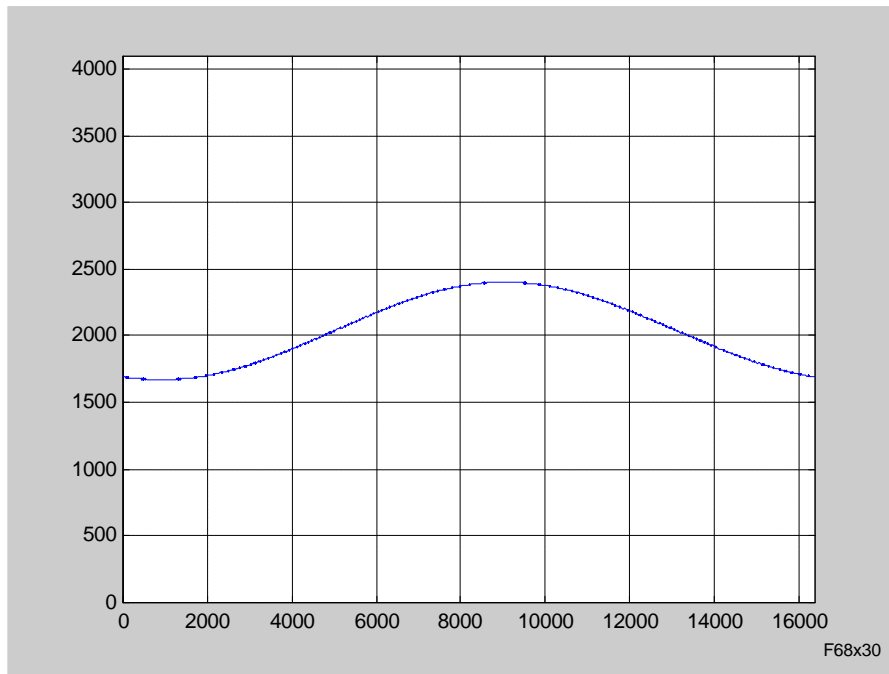

- Figure 24. Reconstructed signal at 175.4MHz@52Mps -

9. DEMOBOARD FILES:

9.1 TDA8768AH/TDA8768BH VERSION:

All documents needed for the realization of this Demoboard are given on **Figures 25 to 30**.

- Electrical diagram.
- Topside component implantation.
- Underside component implantation.
- Topside component layout 1.
- Internal ground plane layout 2.
- Underside component layout 3.

9.2 COMPONENTS LIST:

The components list with their values and references for all versions is given on **Tables 5 to 6**.

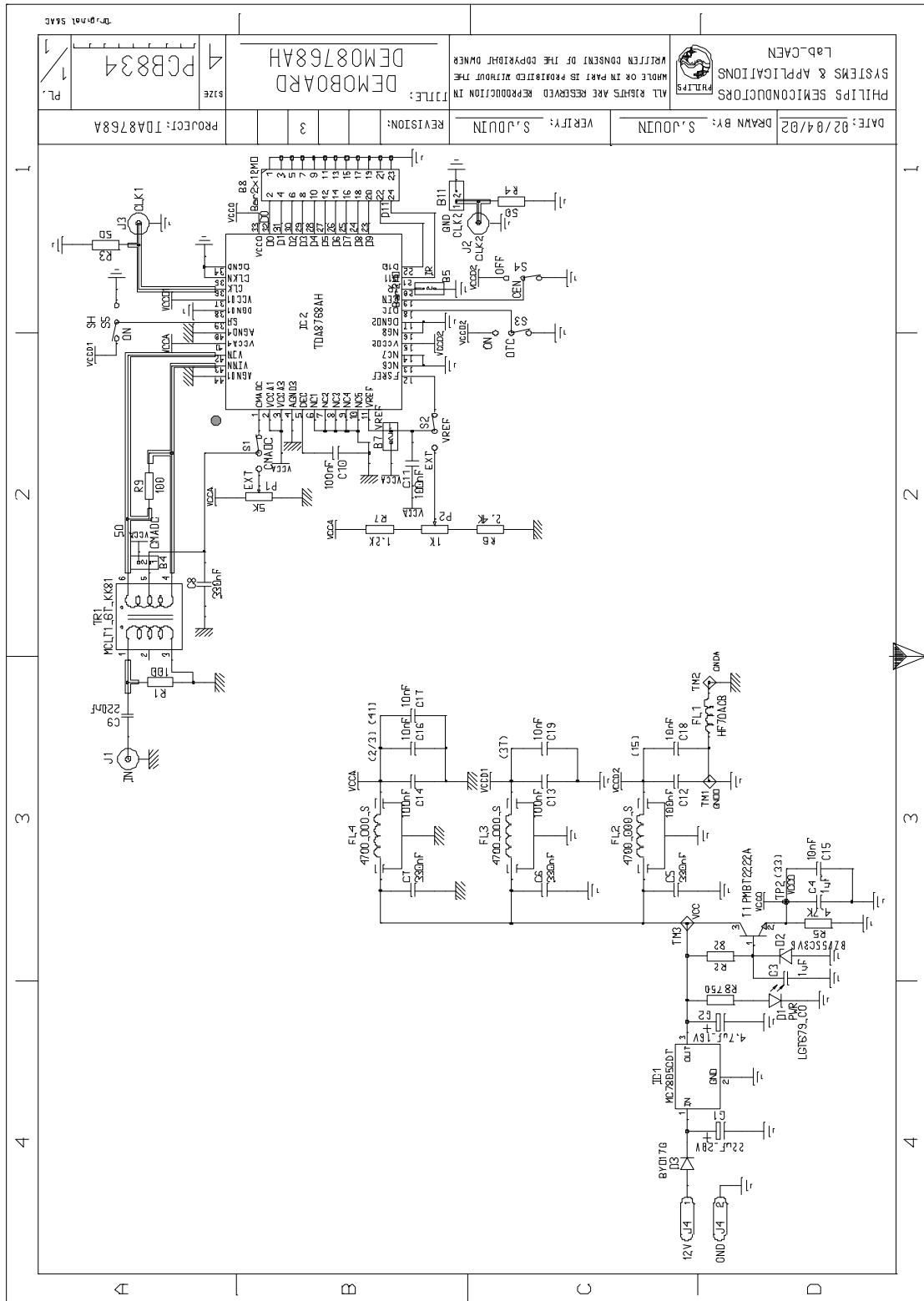

F68x22

- Figure 25. TDA8768AH/TDA8768BH Demoboard electrical diagram -

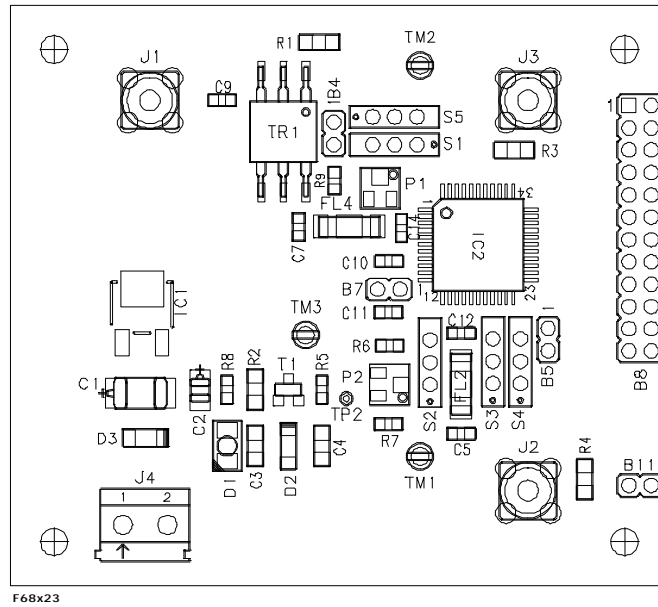

- Figure 26. TDA8768AH/TDA8768BH topside component implantation -

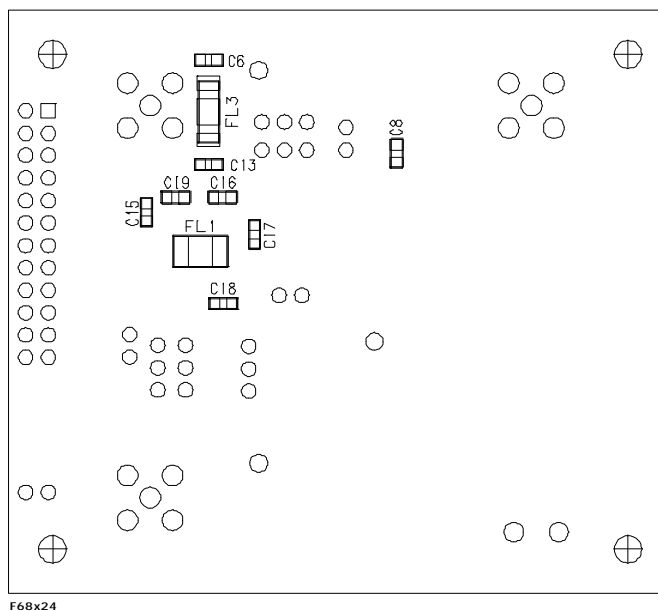

- Figure 27. TDA8768AH/TDA8768BH underside component implantation -

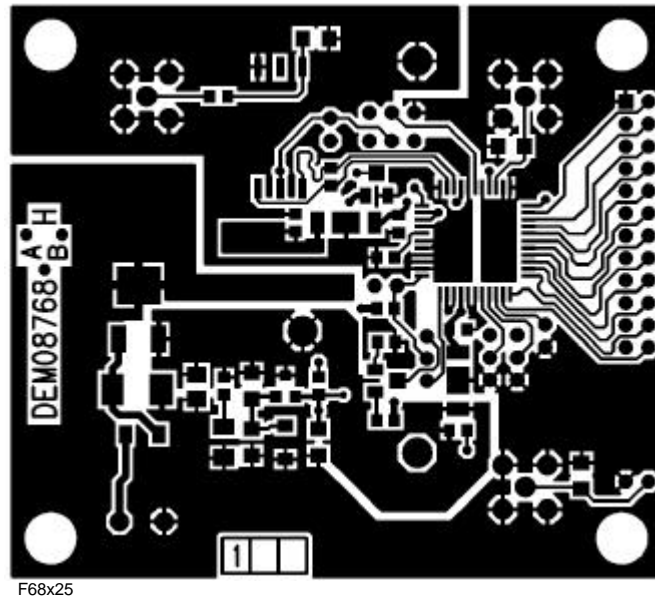

- Figure 28. Topside component layout (signal layer 1) -

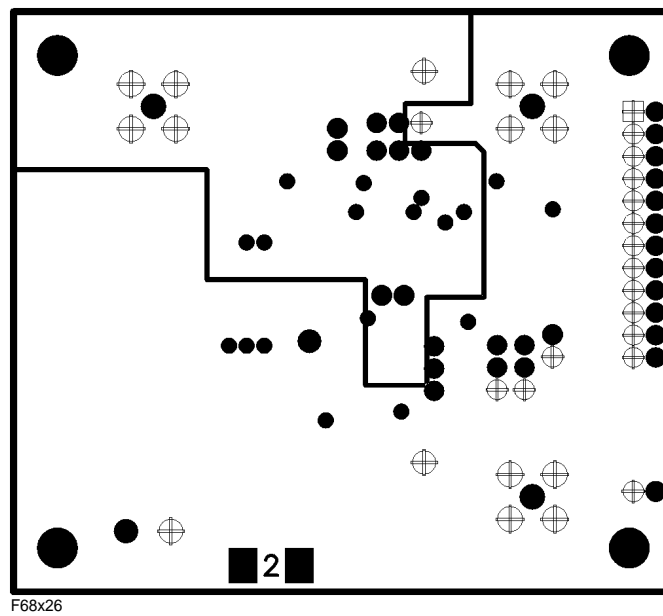

- Figure 29. Internal plane layout (ground layer 2) -

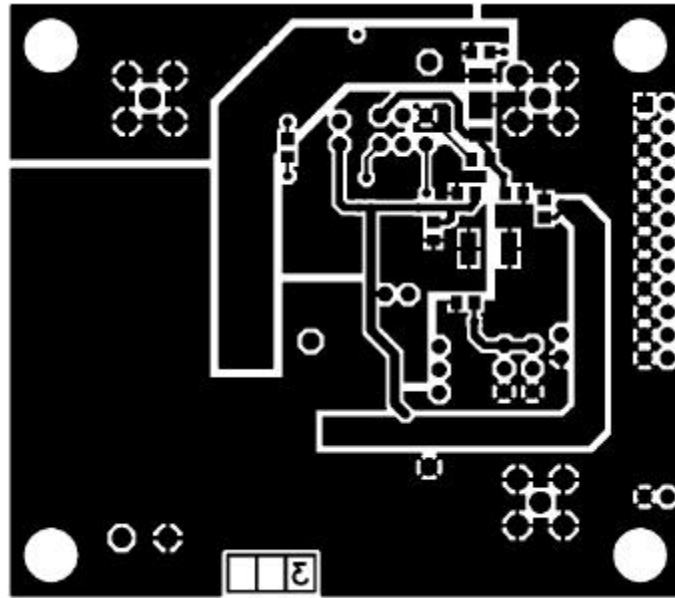

F68x27

- Figure 30. Underside component layout (supply layer 3) -

REF	VALUE	COMPONENT	TYPE	MANUFACTURER
C1	22 μ F/20V	CAPACITOR	293D/C	SPRAGUE
C2	4.7 μ F/16V	'	293D/A	'
C3	1 μ F	'	C1206	PHILIPS
C4	1 μ F	'	'	'
C5	330nF	'	C0805	'
C6	330nF	'	'	'
C7	330nF	'	'	'
C8	330nF	'	'	'
C9	220nF	'	'	'
C10	100nF	'	'	'
C11	100nF	'	'	'
C12	100nF	'	'	'
C13	100nF	'	'	'
C14	100nF	'	'	'
C15	10nF	'	'	'
C16	10nF	'	'	'
C17	10nF	'	'	'
C18	10nF	'	'	'
C19	10nF	'	'	'
D1		GREEN LED	LGT679-CO	SIEMENS
D2		ZENER DIODE	BZV55C	PHILIPS
D3		DIODE	BYD17G	'
T1		NPN TRANSISTOR	PMBT2222A	PHILIPS
TR1		RF TRANSFORMER	MCLT1-6T-KK81	MINI-CIRCUIT
FL1		HF70ACB-453215T	C1812	PHILIPS
FL2	2nF	II FILTER	4700-003-S	TUSONIX
FL3	2nF	'	'	'
FL4	2nF	'	'	'
IC1		VOLTAGE REGULATOR	MC78M05CDT	MOTOROLA
IC2		ADC	TDA8768AHTDA8768BH	PHILIPS
J1	50 Ω	CONNECTOR	SMA	RADIALL
J2	50 Ω	'	'	'
J3	50 Ω	'	'	'
J4		'	MKSD	PHOENIX
S1		SWITCH	1C2P	SECME

- Table 5. List of components(1/2) -

REF	VALUE	COMPONENT	TYPE	MANUFACTURER
S2		SWITCH	1C2P	SECME
S3		'	'	'
S4		'	'	'
S5		'	'	'
L1		HF70ACB-453215T	C1812	PHILIPS
P1	5K Ω	POTENTIOMETER	3224W	BOURNS
P2	1K Ω	'	'	'
Y1	80MHz	OSCILLATOR	IQX0	KONY
R1	100 Ω	RESISTOR	1206	PHILIPS
R2	82 Ω	'	'	'
R3	50 Ω	'	'	'
R4	50 Ω	'	'	'
R5	4.7k Ω	'	0805	'
R6	2.4k Ω	'	'	'
R7	1.2k Ω	'	'	'
R8	750 Ω	'	'	'
R9	100 Ω	'	'	'
TM1		MEASUREMENT POINT		COMATEL
TM2		'		'
TM3		'		'
B4		TEST POINT	2x1	COMATEL
B5		'	'	'
B7		'	'	'
B8		'	2x12	'
B11		'	2x1	'

- Table 6. List of components(2/2) -

10. ALGORITHMS USED:

The FFT functions written for Matlab[®] version 5.2 used **only** for the Demoboard evaluation are given below. The `adcfft` function works with `fclk>fi` (`fs>fin`).

```
function adcfft(sample,n,fs,fin)
% ADCFFT processes the fft from the binary ADC sample signal.
% ADCFFT(SAMPLE,N,FS,FIN) returns the DFT plot and others informations.
% SAMPLE must be the matrix of ADC sample signal.
% N must be the ADC number of bits.
% FS must be the ADC sample frequency (in MHz) with precision.
% FIN must be the ADC input signal frequency (in MHz) with precision.
%
% Example
%     adcfft(data,10,40.07792379,4.430000)
%         returns the DFT plot, the fondamental, the
%         sixth first harmonics, the THD, the SINAD,
%         the SNR, the SFDR and the E values.
%
% THD: Total Harmonic Distortion (with second to sixth harmonics).
% SINAD: Signal to Noise And Distortion ratio.
% SNR: Signal to Noise Ratio.
% SFDR: Spurious Free Dynamic Range.
% E: Effective number of bit without correction.
%
% Copyright (c) 1998/2002 S&A-DCPL Philips Semiconductors
% $Revision: 4.0 $ $Date: 15/V/2002 $
%
% Written by Stephane Jouin

d=length(sample);
x=linspace(0,fs,d);
Pxx=abs(fft(sample,d)).^2/d;
Pxxl=10*log10(Pxx);
mindb=min(Pxxl);
first=Pxxl(1);
Pxxl(1)=0;
maxdb=max(Pxxl);
max2db=0;
for i=2:(d/2)+1
```

```
    if maxdb~=Pxxl(i)
        if max2db<Pxxl(i)
            max2db=Pxxl(i);
        end
    end
end
Pxxl(1)=first;
Pxxl=Pxxl-maxdb;

%Process of six first harmonics (with fondamental)
nh=6;
ep=0;
for i=1:nh
    for j=1:i+2
        if i*fin>fs/2
            ep=abs(i*fin-j*fs);
        else
            ep=i*fin;
        end
        if ep<=fs/2
            for q=2:length(x)
                if ep>=x(q-1)
                    if ep<=(q+1)
                        h(i)=ep;
                        ph(i)=Pxx(q);
                    end
                end
            end
        end
    end
end
end

%THD: (with the 'nh-1' first harmonics)
sh=0;
for i=2:nh
    sh=sh+ph(i);
end
thd=10*log10(ph(1)/sh);

%SFDR:
sfdr=max2db-maxdb;
```

```
%SINAD:
sn=0;
for i=2:(d/2)+1
    sn=sn+Pxx(i);
end
sn=sn-ph(1);
sinad=10*log10(ph(1)/sn);

%SNR:
for i=2:nh
    sn=sn-ph(i);
end
snr=10*log10(sum(ph)/sn);

%E:
e=(sinad-10*log10(3/2))/(20*log10(2));

%Plot
plot(x,Pxx1);
xlabel('Frequency(MHz)');
ylabel('Power Spectrum(dBc)');
title(['FFT: Size: ',num2str(d,10),'samples/fclk: ',num2str(fs,10),'MSPS/fi: ',num2str(fin,10),'MHz']);
for i=1:nh
    text(0,(-4*i)-i+1,[num2str(i),'fi: ',num2str(h(i),3),'MHz',':',num2str(10*log10(ph(i))-
maxdb,4),'dBc']);
    text(h(i),(10*log10(ph(i))-maxdb),[num2str(i)],'FontSize',8);
end
text(0,(-4*i)-12,['THD(',num2str(nh-1),'H.):',num2str(thd,4),'dBc']);
text(0,(-4*i)-17,['SFDR:',num2str(sfdr,4),'dBc']);
text(0,(-4*i)-22,['SINAD:',num2str(sinad,4),'dB']);
text(0,(-4*i)-27,['SNR:',num2str(snr,4),'dB']);
text(0,(-4*i)-32,['E:',num2str(e,4),'bit']);
axis([0 fs/2 mindb-maxdb 0]);
grid;
```

```
function adcrs(sample,n,fs,fin)
%ADCRS processes the reconstructed sinewave from the binary ADC sample signal.
% ADCRS(SAMPLE,N,FS,FIN) returns the reconstructed sinewave plot and others informations.
% SAMPLE must be the matrix of ADC sample signal.
% N must be the ADC number of bits.
% FS must be the ADC sample frequency (in MHz) with precision.
% FIN must be the ADC input signal frequency (in MHz) with precision.
%
% Example
%   adcrs(data,10,40.07792379,4.430000)
%       returns the reconstructed sinewave plot.

% Copyright (c) 2000/2002 S&A-DCPL Philips Semiconductors
% $Revision: 1.0 $ $Date: 08/IX/2000 $

% Written by Stephane Jouin

warning off;

N=length(sample);
k=(fin/fs)*N;
for i=1:N
    rs(i)=k*i-N*fix(i*k/N);
end
for i=1:N-1
    y(rs(i))=sample(i);
end

plot(y);
title(['Rec. sinewave: Size: ',num2str(N,10),'samples/fclk: ',num2str(fs,10),'MSPS/fi: ',num2str(fin,10),'MHz']);
text(0,min(y),[num2str(min(y))],'FontSize',8);
text(0,max(y),[num2str(max(y))],'FontSize',8);

axis([0 N 0 2^n]);
grid;

warning on;
```